



**idi**

INGEGNERIA DEGLI IDROCARBURI S.r.l.



**SY.@.S.**

SY.A.S. System Automation Services S.r.l.



## THE SMART SOLUTION FOR YOUR PROJECTS

Three excellences from the world of Engineering and Construction combine their experience to offer technical and professional solutions tailored to the most demanding challenges of today's industrial world



## THE ENGINEERING SOLUTION TAILORED TO THE INDUSTRY

Chemical Industry  
Circular Economy / Renewable Energy  
Oil & Gas  
Energy  
Food and Commodities  
Logistics

IDI - Via Boncompagni, 3/B - 20139 Milano (0)2-55.21.1247

SY.A.S. - Via Pitteri, 110 - 20134 Milano (0)2-26.41.63.95

RP Sarda - Via Giotto, 18 - 09018 Sarroch (CA) (0)70-90.20.36



## ABOUT US - OUR HISTORY

Our Group represents a dynamic reality in the engineering world that was born from the alliance of three leading companies. Starting from the 1970s we serve the Engineering market in the fields of Plant Engineering, Chemical Processes, Energy and Automation.

Our Group offers services for Feasibility Studies, Basic Design, Detail Design, Procurement and Inspection services, Support and Assistance to Construction and Operator Training activities.

Our group is structured to develop a volume of 130.000 man-hours of engineering activities per year, with the ability to coordinate external specialized companies, able to provide further specialist support to extend our offer.

## OUR MAIN BUSINESS AREAS



CHEMISTRY



OIL & GAS



POWER



FOOD & BEVERAGE



LOGISTICS



RENEWABLE

## OUR ORGANIZATION

In the course of each project, our Customers can rely on a flexible organization tailored to their specific needs.

Our project organization always reports to a senior Project Manager with many years of experience.

Our technical organization relies on all specialties capable of promptly providing competent and effective answers to your requirements.

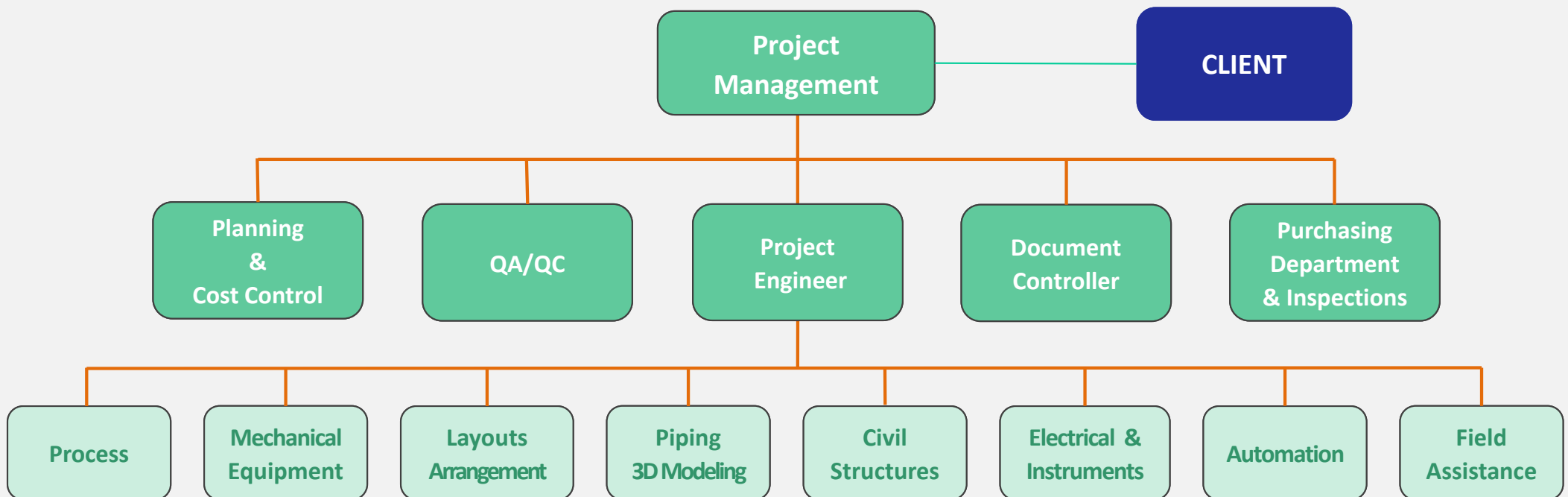

## ABILITY TO DEAL WITH MEDIUM-SIZE PROJECTS

Thanks to a multidisciplinary organization of about 130,000 man-hours/year, our Group can deal with industrial projects of considerable size.

More specialized activities are addressed with the support of external partners, usually operating inside our team on various ancillary specializations:

- Safety, Firefighting, F&G, HAZOP, Environment.
- Design of Heat exchangers and Pressure equipment.
- Structural Engineering.
- Industrial Furnace Design.
- CAD systems and 3D modeling.

In any case, the interface to the Customer remains unique, for the complete benefit of the Customer and the project.

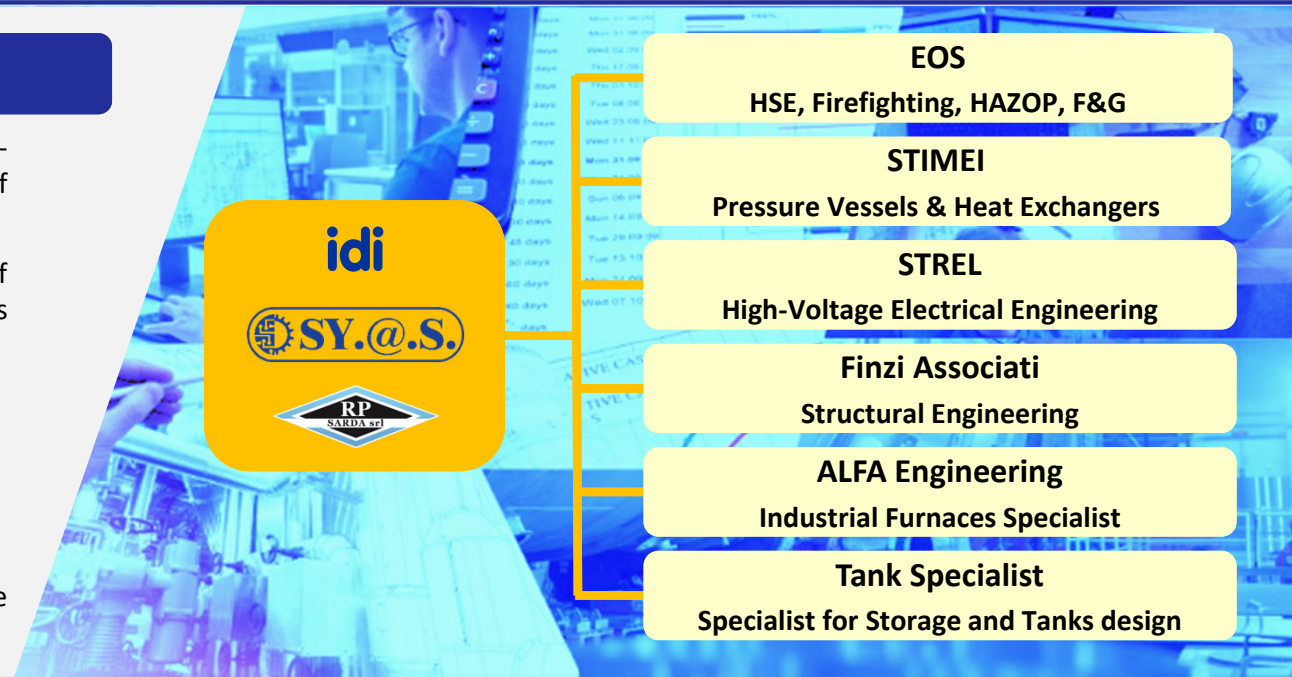

## TOTAL HOURS PER YEAR PER SPECIALTY

| Company | Process | Piping | Stress Analysis | Mechanic Pressure Vessels | Civil Structures | Electro Instrumental | Automation | Inspection Construction Supervision | Staff Commercial | Total   |
|---------|---------|--------|-----------------|---------------------------|------------------|----------------------|------------|-------------------------------------|------------------|---------|
| IDI     | 8.000   | 10.800 | 1.800           | 3.600                     | 5.400            | 3.600                |            | 7.000                               | 3.400            | 43.600  |
| RP      |         | 21.600 | 1.800           |                           | 5.400            | 3.600                |            | 3.600                               | 3.600            | 39.600  |
| SY.A.S  |         |        |                 |                           |                  | 18.000               | 23.400     | 3.600                               | 1.800            | 46.800  |
| Total   | 8.000   | 32.400 | 3.600           | 3.600                     | 10.800           | 25.200               | 23.400     | 14.200                              | 8.800            | 130.000 |



## QUALITY – IS OUR PRIMARY OBJECTIVE

Our decades-long collaboration with large and demanding companies has led us to systematically adopt Operational Standards of recognized excellence.

We are aware that our “Customer Satisfaction Policy” is the first target of our business.



## PROJECT MANAGEMENT

Each of our projects, no matter its size, is followed in all its phases by one of our qualified Project Managers whose first professional target is the full satisfaction of the Client. Among the main tasks of our Project Managers:

- Set the project targets in agreement with the Client.
- Share information to stakeholders and Client.
- Develop plans and sets timelines in agreement with the Client.
- Set the project financial budget.
- Allocates resources: technologies, personnel, material and contracts.
- Check each phase of the project with full responsibility for the result.
- Manage and lead the project team.
- Establish procedures within a project: risk management, dispute management, change management, communication management.



## PLANNING / INVESTMENT ESTIMATES AND COST CONTROL

No project can be defined successful if it does not respect the estimated times and costs. From the very first stages of setting up the technical activities, our Planning and Cost Control team works in concert with the technical staff so that financial resources and programs are established in a reliable way.

Our offer is as follows:

- Cost estimate through our database, through customer database and / or through market evaluations.
- Evaluation of investment returns, also with the use of statistical techniques (e.g.: Montecarlo risk analysis).
- Cost control during all project phases with supplier/site feedback.
- Investment scheduling based on our database, client database and times negotiated with suppliers.
- Periodic progress check on the base of feedback from the engineering department, suppliers and construction site.

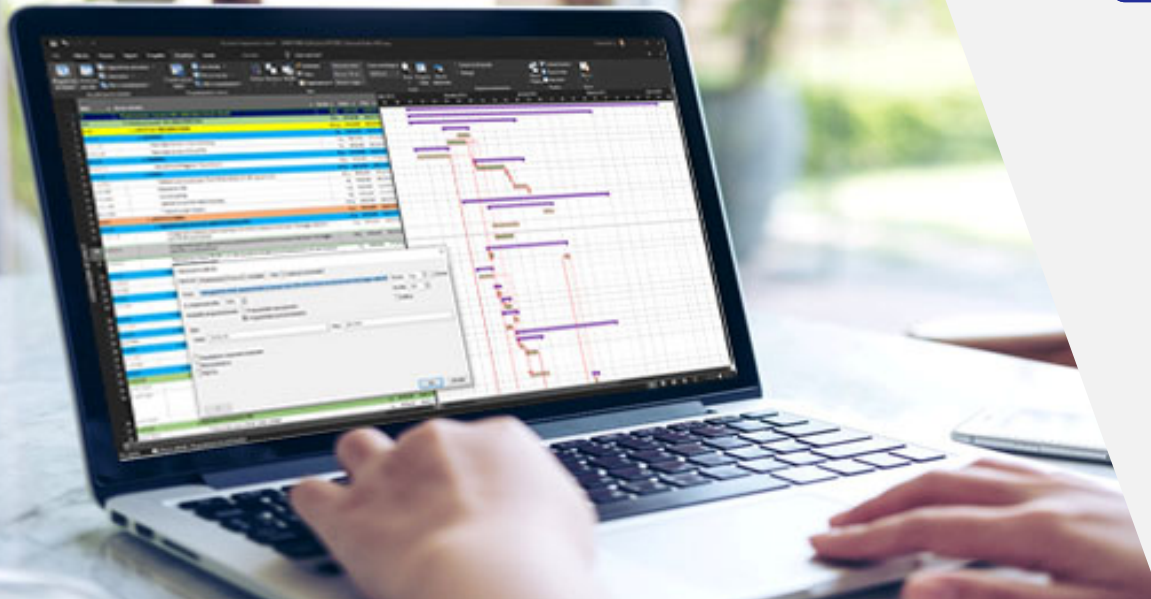

## FEASIBILITY STUDIES - PROCESS SIMULATION

Our experience in process design has a very long history that begins in the 70s. Since the 80s, process simulation has become part of our DNA with applications that have constantly satisfied our customers. Among the excellences of ours we boast about a primary experience in the following areas:

- Feasibility studies and technological scouting
- Client assistance for technology transfer activities, support for the acquisition of new licenses and patents.
- Endorsement of basic engineering produced by third parties.
- Process optimization.
- Process simulation oriented to design, optimization and control.
- Technical assistance in legal actions on disputes related to know-how and patents.

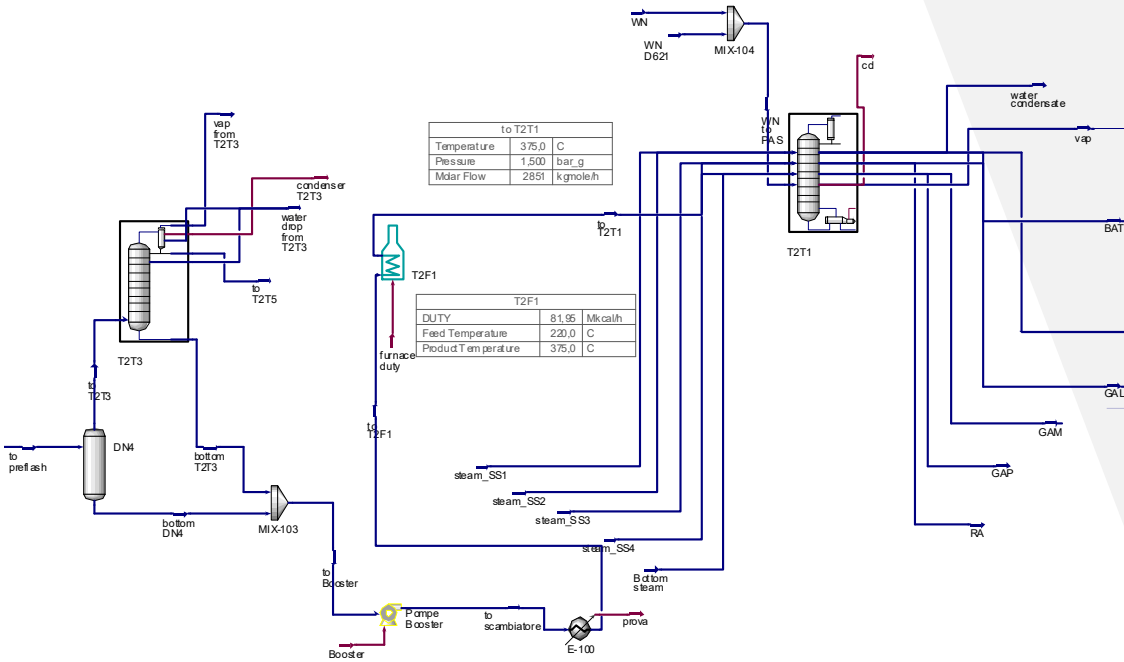

## PROCESS DESIGN - TROUBLESHOOTING

Our process experience has steadily grown over time with the development of successful applications that have covered the most diversified sectors of Chemical Engineering and Energy production:

- Plants for chemical products.
- Refining and natural gas facilities.
- Petrochemical processes.
- Energy production.
- Refrigeration systems.
- Processes for Plastic Materials.
- Pipelines, Storage, Logistics for product loading.
- Design of Packaged Plants.
- Training of Plant Operators.
- Plant start-up assistance.
- Development of plant operating manuals and guidelines.
- Process troubleshooting.



## MECHANICAL ENGINEERING

Of fundamental importance for the development of multidisciplinary projects, the mechanical department represents for our Group one of the main specialties qualified for dealing with the most demanding assignments encountered in plant design:

- Study and definition of the plant layout.
- Design of pressure equipment.
- Thermal and mechanical design of heat exchangers.
- Machinery selection and specification.
- Piping and stress analysis.
- Furnace design.
- Skid-mounted plants design.
- Storage tank design.



## MECHANICAL ENGINEERING - EQUIPMENT

Main activities developed by our Group in this area:

- Item List Processing.
- Equipment technical Data Sheets processing.
- Materials selection.
- Development of "material requirements" for equipment (including machinery).
- Mechanical design and mechanical verification for pressure equipment.
- Thermal design and thermal verification of heat exchangers and furnaces.
- Development of all procurement documentation for mechanical erections.
- Development of 'technical material requisitions' for all ancillary activities of painting, insulation, etc.
- Spare parts management.

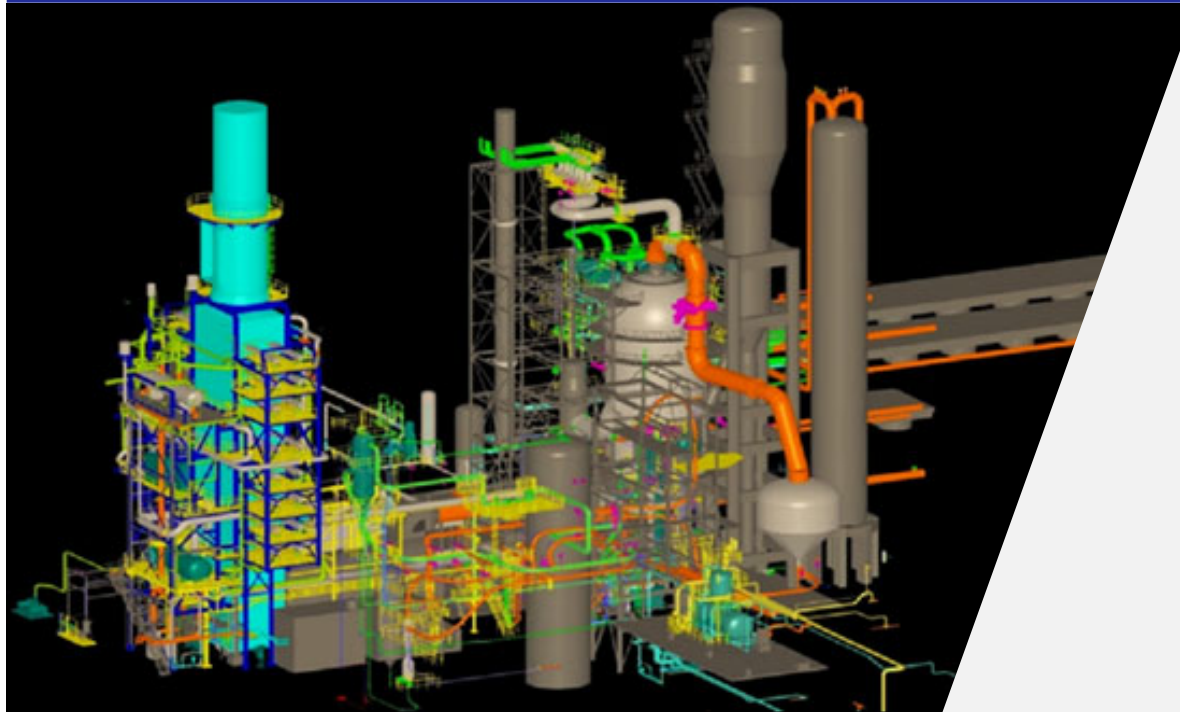



## PIPING ENGINEERING AND 3D MODELING

Main activities developed by our Group aimed at the development of mechanical engineering for piping:

- Elaboration of isometric drawings.
- Modeling of the piping-layout using 3D CAD systems.
- Laser scan survey.
- Integration of laser scan data into the design environment.
- Plant Layout engineering for piping and equipment.
- Development of material lists.
- Piping Stress and Flexibility analysis.
- Piping Surge analysis.
- Sizing and positioning of the piping supports.
- Technical specifications for painting, insulation, etc.
- Studies for pipelines construction.

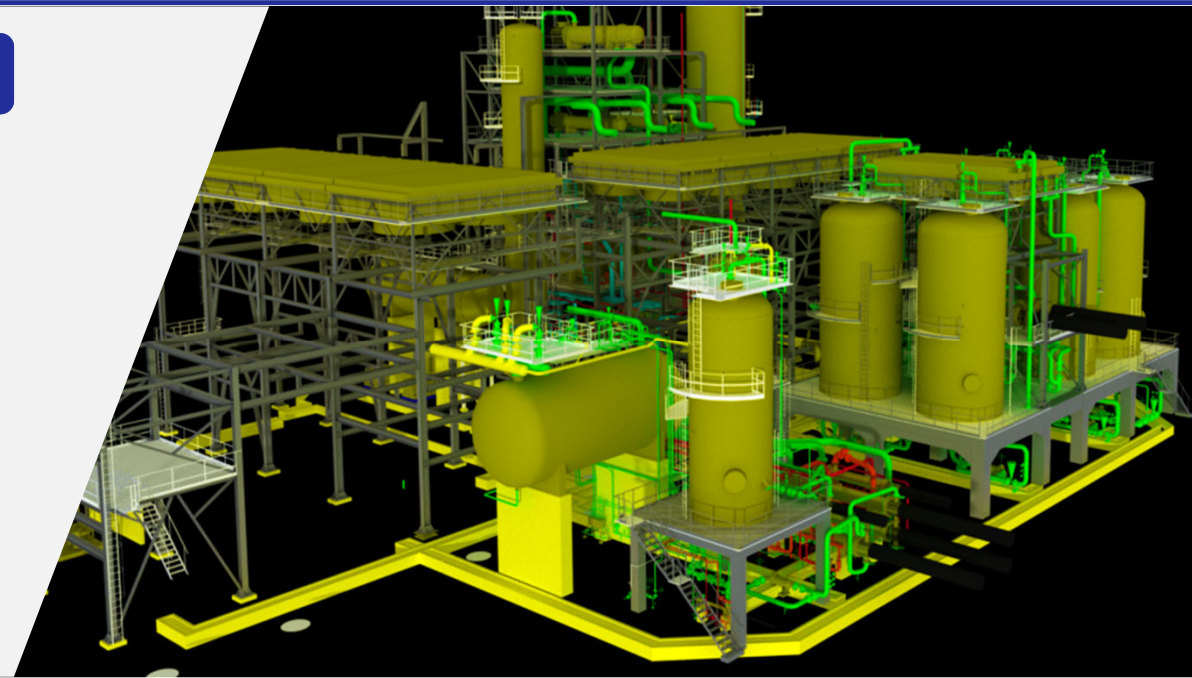

## PACKAGES ENGINEERING

Our Group was among the first promoter of plant modularization technology, seen as an ideal tool to increase process reliability, significantly reduce installation costs and reduce construction site risks:

Some of our most significant experiences have been developed in the following areas:

- Refrigeration systems.
- Systems for addition and dosage.
- Gas treatment and effluent recovery systems.
- Analysis, sampling and measurement systems.
- Heating systems and combustion systems.
- Pumping and compression systems.
- Transfer and loading systems.

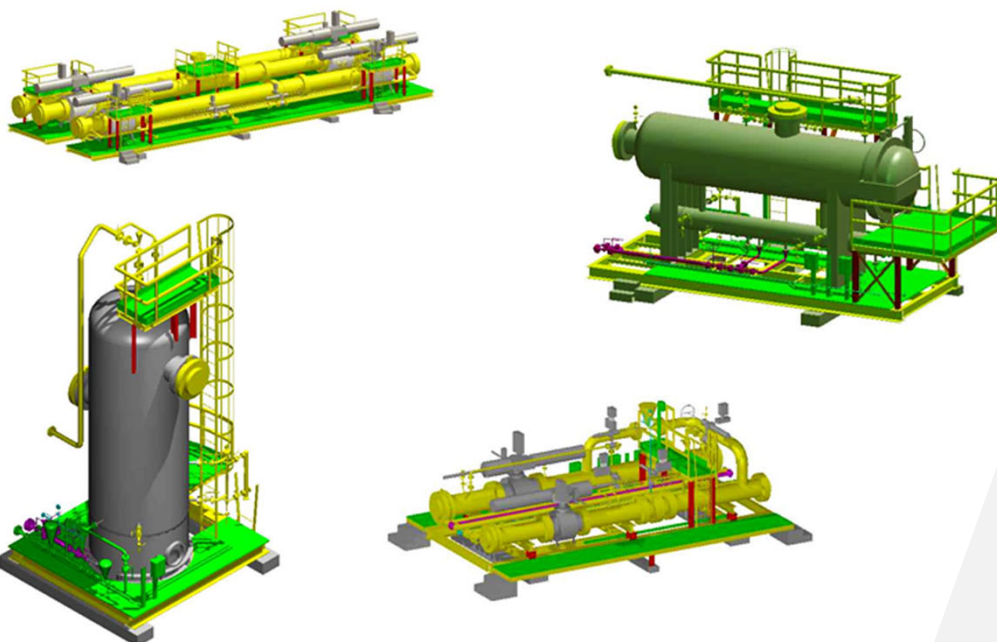



## CIVIL ENGINEERING DESIGN / AUTHORIZATIONS

Our civil engineering department has the competence to respond comprehensively to all the demanding projects that typically are faced during the development of industrial initiatives.

Among the activities that we can carry out for authorization requests we point out by way of example:

- Documentation for Building Permit.
- Documentation for Compliance with Landscape Plans.
- Documentation for compliance with structural stability standards.
- Environmental Impact and compliance with Fire Protection standards (developed in collaboration with our partner EOS).
- Request for authorization in compliance with the noise limits (developed in collaboration with our partner EOS).
- Safety and Coordination Plan in the Design and Executive phase.

## CIVIL AND STRUCTURAL DESIGN

As regards civil and structural design, our offer includes a range of services that we can list as follows:

- Topographic survey.
- Engineering for earthmoving operations.
- Geotechnical design and earthquake risk assessments.
- Architectural and structural design.
- Specialized structural design for civil and marine infrastructures.
- Investment estimates.
- Detailed design for buildings / industrial structures / warehouses.
- Detailed design for foundations of machinery and equipment.
- Detailed design for steel structures.
- Finite element based structural analysis and seismic analysis.
- Design of hydraulic systems.
- Design of foundations for storage tanks;



## INSTRUMENTATION AND CONTROL SYSTEMS

Decades of experience on industrial control systems of various types make us one of the reference points for the engineering of the sector.

Our offer is structured to cover every industrial need, from the complexity of DCS distributed systems for the control of large refining plants to PLC systems for small industrial companies:

- Automation and Process Control (DCS, PLC, etc.).
- Automation and industrial control services through integration of DCS and PLC systems.
- Development of graphic interfaces, supply of control panels, terminal and interface panels, IPDP distribution panels, supervision console.
- Integration of mechanical and instrumentation schemes (P & IDs).
- Development of instrumentation diagrams and detailed data sheets for field instrumentation.
- Instruments specification and selection.

## ELECTRICAL DESIGN

On the subject of electrical design, our offer includes several specialties as follows:

- Feasibility studies.
- Electrical balances.
- Development of wiring diagrams.
- Production of detailed equipment data sheets.
- Technical evaluation and specifications for panels, transformers, DC and AC motors, etc.
- Distribution boards and F.M. low voltage.
- Classification of hazardous areas according to international codes.
- Design of ground networks and related data sheets.
- Design of lighting and communication systems.
- Electrical systems certification pursuant to applicable standards.



## AUTOMATION

In recent years, the industrial world has witnessed a strong technological acceleration in the automation sector with initiatives inspired by the new wave of "Industry 4.0" that have taken automation to higher levels than in the past.

This translates into a greater and greater sophistication of automation systems, which relying on large amounts of data and guarantee in any case the best possible response and integration between the control systems. Every single operation must be managed through validated tools that guarantee safety and maximization of the economic return.

Our Group is experiencing this transition as a protagonist, with the strengthening of the division specialized in automation applications and advanced automation, able to offer the following services:



## AUTOMATION

- Analysis and study of the automation projects.
- Control and automation systems engineering.
- Detailed engineering of control room, control and automation systems.
- Engineering development of system cabinets and interconnection.
- Development of power distribution panels for control and automation.
- Development of functional and wiring diagrams.
- Logical schema development.
- Development of regulation strategies for controls and advanced controls.
- Development and implementation of application software and graphic operator interfaces.
- Integration of control and automation systems.
- Development of safety instrumental systems (SIS) developed by FS Engineer certified specialists.
- Coordination and execution of acceptance tests in the factory and on site (FAT, SAT).



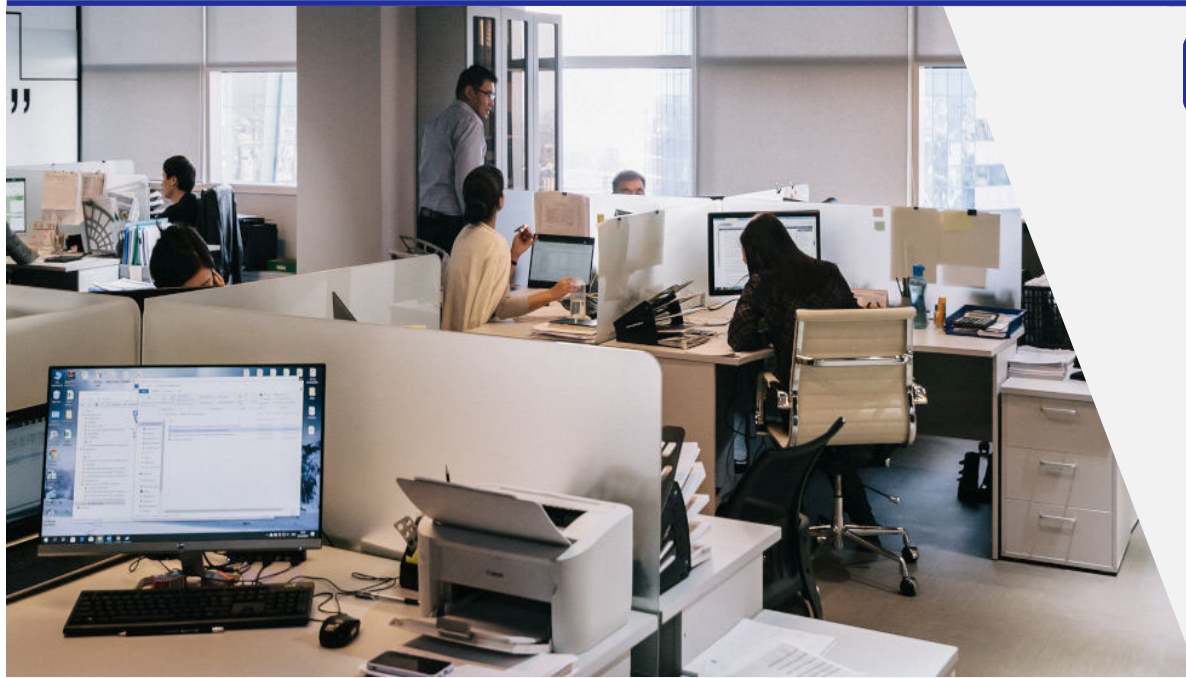

## PURCHASES AND PROCUREMENT

Our Group can provide full support to the management of all phases of purchase and contract emission in support or in replacement of the Customer:

Among the main services we perform:

- Vendors selection based on customer preferences or our extensive database.
- Preliminary scouting of market prices.
- Technical / commercial assistance throughout the bidding phase.
- During the purchasing phase we can provide a service for managing bidders, technical and commercial alignment and tabulation, assistance during economic negotiations, emission of orders in the name and on behalf of the customer.

## EXPEDITING AND TESTS

In the world of furniture anything can happen, those who have decades of experience in the field of expediting are aware of this.

The situation is driven more and more by the economic pressure that leads to the search for new suppliers, often geographically far from the customer.

Our Group offers a complete control service in this area which includes:

- Expediting for monitoring the progress of suppliers.
- Expediting with inspection at the supplier's workshops and warehouses before goods are shipped.
- Technical checks on materials with control of: compliance with project specifications, compliance with certificates and standards, laboratory tests, etc.
- Inspection and technical support during third party tests.



## SITE SUPERVISION AND ASSISTANCE

The construction phase always represents the most critical phase of the project, the phase in which all the ideas and conceptual efforts of the designers must find practical implementation.

Even in this phase our people are at the Client's side to support him in achieving the project objectives.

Our group can provide the following construction site services:

- Assistance and supervision during the construction phases.
- Materials management and preliminary verification of prefabrication.
- Planning of construction at site.
- Verification of accounting, even in conflict with contractors.
- Activities for plant pre-commissioning and commissioning.
- Process assistance in the course of plant performance test-run.



## OPERATORS TRAINING

The obligation of information, education and training of workers in charge of the use of the work equipment made available to them is usually contained in most of the legislations of industrialized countries.

According to these rules, the Employer must ensure that for each work equipment, the workers assigned to its use have adequate safety education and training.

Aware of the difficulties of ensuring an adequate response to these requirements for each new construction, from the first operation day, our Group supports the Customer with our instructors and with adequate training course capable of guaranteeing certified training for the personnel who will have to operate on the new plant.



OUR GROUP HAS REFERENCES WITH PRESTIGIOUS COMPANIES



## OUR MAIN OFFICES



### **IDI Main Office**

Via Boncompagni, 3/B  
I - 20139 Milano  
Tel. +39 (0)2-55.21.1247  
Web [www.idispa.com](http://www.idispa.com)

### **SY.A.S. Main Office**

Via Pitteri, 110  
I - 20134 Milano  
Tel. +39 (0)2-26.41.6395  
Web [www.syas.it](http://www.syas.it)

### **RP SARDA Main Office**

Via Giotto, 18  
I - 09018 Sarroch CA  
Tel. +39 (0)70-90.20.36  
Web [www.rpsarda.it](http://www.rpsarda.it)

